

HF LS LI | Sensors for light management systems



Product family features

- Light and presence sensor for luminaire installation or attachment
- Presence detection via active radar sensor element
- Function indicator with two-color LED
- Motion detection range adjustable
- Mounting height: 2...13 m
- Light sensor operating range: 20...800 lx (measured at sensor)
- Integrated infrared remote control receiver
- Connection via polarity reversal protected 4p4c socket (RJ10)

Product family benefits

- Individual activation/deactivation of light and presence sensor via remote control
- $V(\lambda)$ corrected light sensor element

Areas of application

- Installation in IP protected luminaires possible
- Corridor lighting control in logistic centers and factory halls
- Areas with high ceilings

Product datasheet

Technical data

Dimensions & weight

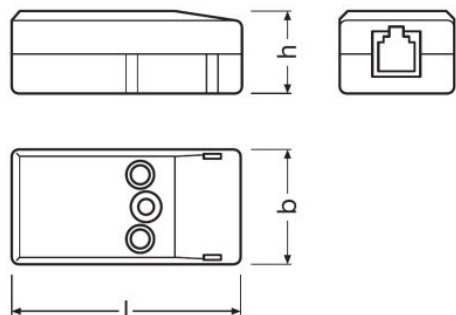

Length	56.0 mm
Width	28.0 mm
Height	21.0 mm
Product weight	22.00 g

Colors & materials

Product color	White
---------------	-------

Temperatures & operating conditions

Ambient temperature range	-20...+50 °C
---------------------------	--------------

Capabilities

Maximum installation height	8 m
Detection angle	35...80 °
Operating range, light sensor	20...800 lx ¹⁾
Type of installation	Luminaire attachment/Luminaire integration

¹⁾ Approximately, measured at the sensor

Certificates & standards

Type of protection	IP20
--------------------	------

Logistical data

Commodity code	853650199000
----------------	--------------











Product datasheet

Equipment / Accessories

- Suitable for DALIeco Control unit
- Suitable for DALI Sensor Coupler HF LS LI

490632_HF LS LI detection range wall mounting angle

Download Data

File	
	User instruction HF LS LI
	Brochures DALIeco: Multi-functional light management system (EN)
	Brochures Light is the efficiency booster - LED-based industrial lighting (EN)
	Brochures Light is the efficiency booster - LED-based industrial lighting (DE)
	Declarations of conformity 505227_CE Declaration DALIeco system
	Operating instructions 473257_Operating instructions HF LS LI
	CAD data HF LS LI CAD Data IGS
	CAD data 3-dim HF LS LI CAD step
	CAD data 3-dim HF LS LI CAD Data xT
	CAD data PDF HF LS LI CAD pdf

Product datasheet

Logistical Data

Product code	Product description	Packaging unit (Pieces/Unit)	Dimensions (length x width x height)	Volume	Gross weight
4052899921481		Shipping carton box 25	180 mm x 160 mm x 70 mm	2.02 dm ³	680.00 g

The mentioned product code describes the smallest quantity unit which can be ordered. One shipping unit can contain one or more single products. When placing an order, for the quantity please enter single or multiples of a shipping unit.

Disclaimer

Subject to change without notice. Errors and omission excepted. Always make sure to use the most recent release.