

HIGH BAY | Stand-alone motion sensors with switching contact



Product family features

- Motion sensor with switching contact
- 3 to 10 m: detection of motion by people
- 3 to 13 m: detection of vehicle movement (e.g. fork lift truck)
- Adjustable switch-off delay: 30 s to 20 min
- Maximum power consumption in stand-by mode: 0.25 W

Product family benefits

- Energy savings up to 35 % (compared to manual switching)

Areas of application

- Great installation height
- Industry
- Production halls

Product datasheet

Technical data

Electrical data

Nominal voltage	120...277 V
Mains frequency	50...60 Hz
System wattage	0.60 W

Dimensions & weight

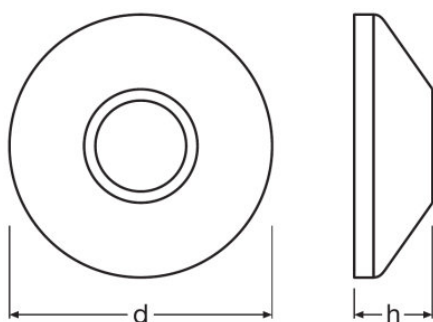

Diameter	116.0 mm
Length	115.6 mm
Width	115.6 mm
Height	40.0 mm
Product weight	135.00 g

Colors & materials

Product color	White
---------------	-------

Temperatures & operating conditions

Ambient temperature range	-10...+70 °C
---------------------------	--------------

Capabilities

Dimmable	No
Maximum installation height	13 m
Detection area	18 m ¹⁾
Detection angle	100 ° ²⁾
Load contact	5 A
Type of installation	On-top ceiling mounting

¹⁾ Maximum diameter

²⁾ Approximately

Product datasheet

Certificates & standards

Type of protection	IP20
Protection class	II







Logistical data

Commodity code	853650809000
----------------	--------------

Equipment / Accessories

- Suitable for up to 15 electronic control gears
- Installation by means of Mounting Adapter possible

Download Data

File
 Brochures Light is the efficiency booster - LED-based industrial lighting (EN)
 Brochures Light is the efficiency booster - LED-based industrial lighting (DE)
 Declarations of conformity 334824_Declaration of conformity – Mounting Adapter
 Declarations of conformity EU Declaration of conformity HIGH BAY VISION SENSOR
 Installation/Operation notice 334311_Technical instructions
 Installation guide 334486_Mounting Adapter Technical instructions
 Installation guide 334723_Technical instructions

Logistical Data

Product code	Product description	Packaging unit (Pieces/Unit)	Dimensions (length x width x height)	Volume	Gross weight
4008321410078		Shipping carton box 20	238 mm x 260 mm x 448 mm	27.72 dm ³	3828.00 g

The mentioned product code describes the smallest quantity unit which can be ordered. One shipping unit can contain one or more single products. When placing an order, for the quantity please enter single or multiples of a shipping unit.

Product datasheet

Disclaimer

Subject to change without notice. Errors and omission excepted. Always make sure to use the most recent release.